

KENWOOD

CONTROLLER FOR DISC AUTO CHANGER / FM MODULATOR SYSTEM

KCA-R41FM

KCA-R31FM

INSTRUCTION MANUAL

KENWOOD CORPORATION

Contents

Before use

Safety precautions	3
Features	5

Disc changer control features

Disc play with Disc auto-changer	6
Track/Disc search	7
Direct track/disc search	8
Track repeat	9
Disc repeat	10
Track scan	11
Disc scan	12
Disc random play	13
Magazine random play	14

Installation

Accessories	15
Changing the transmission frequency	16
Modulation level / Dynamic control	17
Installation procedure	18
Connections	19
Installation	20

Troubleshooting guide	21
------------------------------------	-----------

Specifications	23
-----------------------------	-----------

Safety precautions

Before use

▲WARNING

Take the following precautions to prevent fire and avoid personal injury :

- When extending the ignition cable, battery cable, or ground cable, use 0.75mm² (AWG18) or larger automotive grade cable to avoid cable deterioration or damage to the covering.
- Check that no metal objects (coins, tools, etc.) are left inside the unit to avoid short circuits.
- If you smell or see smoke, turn the power off immediately and consult your Kenwood dealer.

▲CAUTION

Take the following precautions to keep the unit in proper working order.

- Be sure the unit is connected to a 12V DC power supply with a negative ground connection.
- Do not open the top or bottom cover.
- Do not install the unit in places it is exposed to direct sunlight, high heat or humidity, water may splash over it, or dust exists.
- If you need to replace the fuse, make sure the new fuse is of the same type and rating. Using a fuse of a different type of rating may damage your unit. The fuse rating is normally shown on the fuse and fuse box.
- If you need to replace the fuse, unplug the wiring harness before replacing the fuse to prevent short circuits.
- Do not set the remote control on hot places such as above the dashboard (Only KCA-R41FM).

IMPORTANT INFORMATION

This unit is NOT designed to be connected directly to a Disc changer that was manufactured and sold before 1994. If you plan to use such units, please read the following information carefully.

- **To control KDC-C200 / KDC-C300 / KDC-C400**
A CA-DS100 (sold separately as an optional accessory), along with the control box and extension cord supplied with the CD changer, are required.
- **To control KDC-C301 / KDC-C600 / KDC-C800 / KDC-C601 / KDC-C401**
A CA-DS100 (sold separately as an optional accessory), along with the extension cord supplied with the CD changer, are required.
- **KDC-C100 / KDC-C302 / C205 / C705 and Disc changer Manufactured by Other Companies are not compatible with this Kenwood model.**

**FAILURE TO FOLLOW THESE INSTRUCTIONS
MAY RESULT IN DAMAGE TO THIS UNIT
AND/OR THE CD CHANGER**

Safety precautions

Before use

NOTE

- If you have difficulty in installing this unit in your vehicle, contact your Kenwood dealer.
- If it doesn't seem to be working properly, first press the Reset button. If the malfunction persists, consult your Kenwood dealer.

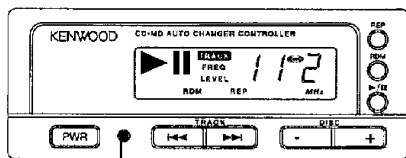

Reset button

FCC WARNING

This equipment may generate or use radio frequency energy. Changes or modifications to this equipment may cause harmful interference unless the modifications are expressly approved in the instruction manual. The user could lose the authority to operate this equipment if an unauthorized change or modification is made.

- Some car stereos cause the sound of the tuner to make for a moment when an engine is activated.
- The reception of the tuner may be reduced a little if the KCA-R41FM / KCA-R31FM is used.
- If the sound is lower than the tuner sound, raise up the volume level of the Disc with using the receiver.

Cleaning the unit

- If the front panel is dirty, wipe it clean with a silicon cloth or soft dry cloth with the power off.

CAUTION

Do not use hard cloths or paint thinner, alcohol, or other volatile solvents. These may damage external surfaces or remove indicator characters.

Features

- **Frequency modulation system**
Even if your car audio(car stereo) is not equipped with an AUX input jack, you can use the radio's built-in FM tuner to listen to music played by the Disc auto changer using FM broadcast frequencies.
One of the twelve transmission frequencies can be set to avoid interference with an (actual) FM broadcast station.
- **Disc changer control (Page 6)**
This unit has a Disc changer control function.
- **Track / Disc search (Page 7)**
You can search for the track / disc you want by specifying the track / disc number.
- **Direct track/disc search (Function of KCA-R41FM) (Page 8)**
This feature allows you to enter the number of the track or disc you wish to hear by pressing the appropriate numeric keys.
- **Track repeat (Page 9)**
When this function is turned on, the track you are listening to is played repeatedly.
- **Disc repeat (Function of KCA-R41FM) (Page 10)**
When this function is turned on, the disc you are listening to is played repeatedly.
- **Track scan (Function of KCA-R41FM) (Page 11)**
When this function is turned on, the first part of each track on the disc you are listening to is played automatically to help you find the one you want.
- **Disc scan (Function of KCA-R41FM) (Page 12)**
When this function is turned on, the first part of each disc in the Disc changer is played automatically to help you find the one you want from the magazine loaded in the Disc changer.
- **Disc random play (Page 13)**
When this function is turned on, the tracks on the disc you are listening to are played in random order.
- **Magazine random play (Function of KCA-R41FM) (Page 14)**
When this function is turned on, the tracks on the discs in your Disc changer are played in random order.
- **Modulation level control (Page 17)**
The modulation level can be changed in the range between 1 to 4 according to the recording level of the disc you are listening to.
- **Dynamic control (Page 17)**
The unit has a prevention of distortion function to reduce sound distortion.

Disc play with Disc auto-changer

Set the car radio FM station to 88.3 MHz. See Page 16 for more information on changing the transmission frequency.

Disc changer control features

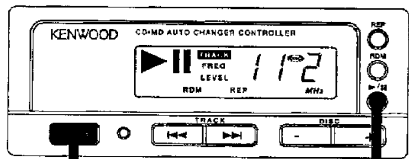

Power button

Play / Pause button

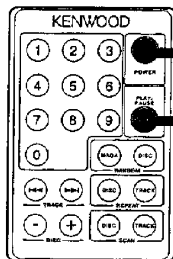

Power button

Play / Pause button

(Supplied with the KCA-R41FM)

To play discs

Press the Power button.
The power goes ON and the disc play start.

To listen to the radio

Press the Power button.
The RF modulator is turned OFF and the radio can be heard.

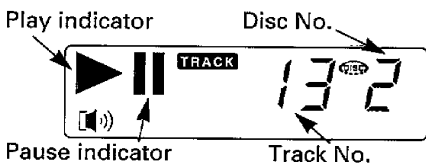

When the player reaches the end of the last track on the disc you are playing, it will shift automatically to the first track on the next disc. When the player plays the last disc, it will return to the first disc. The play indicator blinks during disc replacement. Disc No. 10 is displayed as "0".

Pause

Press the Play/Pause button.
Disc play is temporarily paused. If you press the button once more, the disc is replayed from the paused part.

Power off

Press the Power button.
The power goes OFF.

NOTE

The KCA-R41FM power can also be turned on or off with a remote controller. When the unit receives any signal from the remote controller, the  mark lights up.

NOTE

- Be sure to turn down the volume whenever you listen to the radio or a cassette tape after stopping the disc play.
- During the disc play is being conducted, you are not able to receive ordinary Radio broadcasting because antenna output is switched into disc player's side.

Track/Disc search

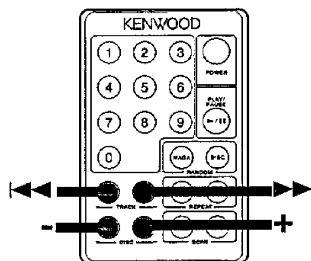
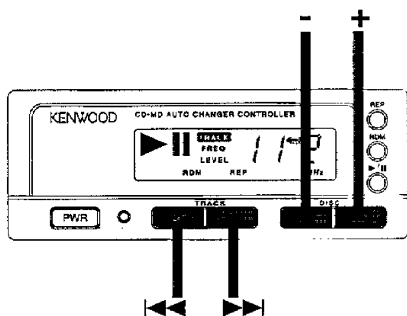

(Supplied with the KCA-R41FM)

Reverse track search

Briefly press the **◀◀** button.

When you press this button once, the player returns to the start of the track you are listening to. Each time you press the button, the track number on the display decreases. The player plays the track with the track number shown on the display.

When the **◀◀** button on the display unit is held down, the player fast-rewinds while playing the track.

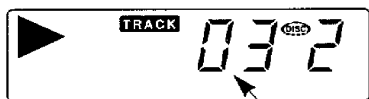

NOTE

If you try reverse track search while playing track 1, the player will resume play at the start of track 1; it does not search for the last track.

Forward track search

Briefly press the **▶▶** button.

Each time you press this button, the track number on the display increases. The player plays the track with the track number shown on the display.

When the **▶▶** button on the display unit is held down, the player fast-forwards while playing the track.

NOTE

If you try forward track search while playing the last track on a disc, the Forward track search function does not work.

Reverse disc search

Press the **-** button.

Each time you press this button, the disc number on the display decreases. The player plays the disc with the disc number shown on the display.



Disc No.

Forward disc search

Press the **+** button.

Each time you press this button, the disc number on the display increases. The player plays the disc with the disc number shown on the display.

Direct track/disc search

Function of the KCA-R41FM

Disc changer control features

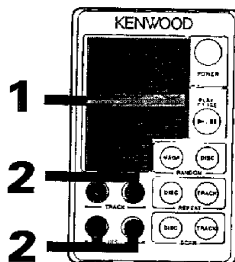

(Supplied with the KCA-R41FM)

1

Enter the number of track or disc you want to listen to. The input number blinks for 10 seconds and stays lit.



NOTE

- To search for disc 10 directly, enter "0".
- If a track number that does not exist on the disc you are listening to is displayed, carry out the operation in step 2, and the direct track search is made to the last track.

2

Direct track search

Press the ◀◀ or ▶▶ button while the number is blinking.

The player starts playing the track specified in step 1.

If three or more numbers are entered, the last two entered digits (shown on the display) are valid.

Direct disc search

Press the - or + button while the number is blinking.

The player starts playing the disc specified in step 1.

When two digits are displayed, the direct disc search is made to the disc number corresponding to the number on the right side.

To cancel

To cancel search in the middle, press the ▶/|| button.

The Direct track/disc search is cancelled and the normal display returns.

Also, if you do nothing for 10 seconds, the search will automatically cancel.

Track repeat

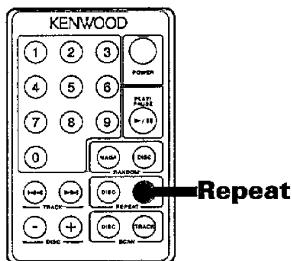
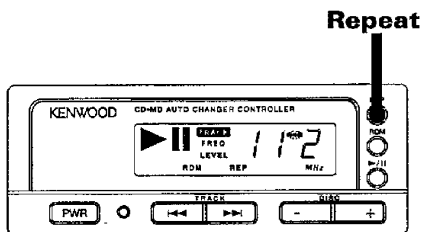

(Supplied with the KCA-R41FM)

Disc changer control features

To repeat track

Press the Repeat button.
The Repeat indicator will appear on the display and the Track repeat function will turn on.
The same track is played repeatedly.



ON

To cancel

Press the Repeat button.
The Repeat indicator disappears and the Track repeat function is cancelled.

NOTE

When disc play stops, Track repeat is cancelled.

Disc repeat

Function of the KCA-R41FM

Disc changer control features

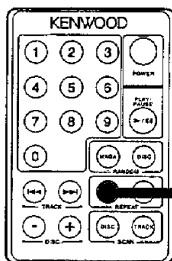

DISC repeat

(Supplied with the KCA-R41FM)

To repeat disc

Press the Disc repeat button.
The Disc repeat indicator will appear on the display and the Disc repeat function will turn on.
The same disc is played repeatedly.



ON

To cancel

Press the Disc repeat button.
The Disc repeat indicator disappears and the Disc repeat function is cancelled.

NOTE

When disc play stops, Disc repeat is cancelled.

Track scan

Function of the KCA-R41FM

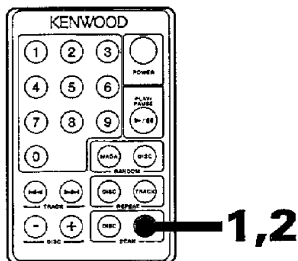

(Supplied with the KCA-R41FM)

1

Press the Track scan button.
The Track scan indicator will appear on the display and the player will play the first 10 seconds of each track in succession.



2

To select a track
Press the Track scan button.
The Track scan indicator disappears and the Track scan is cancelled.
Normal playback starts.

NOTE

- When disc play stops, Track scan is cancelled.
- When all tracks on the disc you are listening to are scanned, Track scan is cancelled.

Disc scan

Function of the KCA-R41FM

Disc changer control features

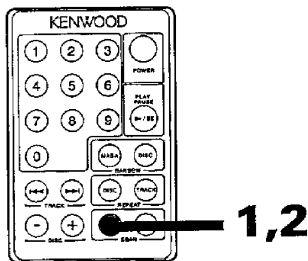

(Supplied with the KCA-R41FM)

1

Press the Disc scan button.
The Disc scan indicator will appear on the display and the player will play the first 10 seconds from each disc in succession.



2

To select a disc
Press the Disc scan button.
The Disc scan indicator disappears and the Disc scan is cancelled.
Normal playback starts.

NOTE

- When disc play stops, Disc scan is cancelled.
- When all discs in the magazine you are listening to are scanned, Disc scan is cancelled.

Disc random play

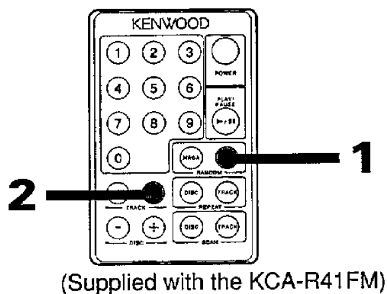
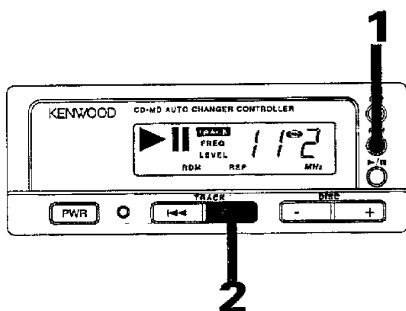

Disc changer control features

1

Press the Disc random button. The Random indicator will appear on the display and the player will randomly select another track from the disc you are playing. The track numbers on the display will change continuously during track selection. When a track is selected, playback will begin automatically.

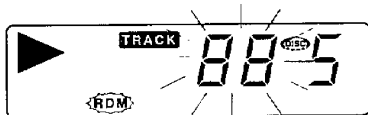

ON

NOTE

When all the tracks on a disc have been played, the player will randomly select the next disc.

2

To select another track
Press the ►► button.
The player will randomly choose another track.

To cancel

Press the Disc random button. The Random indicator disappears and Disc random play is cancelled. Normal disc play starts.

NOTE

When the disc play stops, the Disc random play function is cancelled.

Magazine random play

Function of the KCA-R41FM

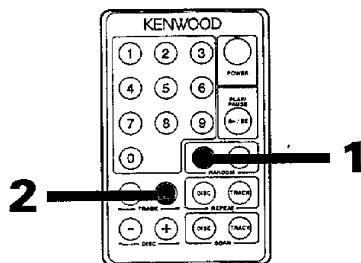

(Supplied with the KCA-R41FM)

1

Press the Magazine random button. The Magazine random indicator will appear on the display and the track select will start. The track/disc numbers on the display will change continuously during track selection. When a track is selected, playback will begin automatically.



ON

NOTE

The Magazine random play is not available if you use the KDC-C200/C300/C400/C301/C401.

2

To select another track
Press the ►► button.
The player will randomly choose another track.





To cancel

Press the Magazine random button. The Magazine random indicator disappears and Magazine random play is cancelled. Normal disc play starts.

NOTE

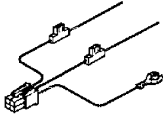
- When disc play stops, the Magazine random play function is cancelled.
- The Magazine random selection time changes according to the number of discs in the magazine.

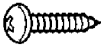
Accessories

Part name	External view	Number of items
Wiring harness		1
Metal fixture		2
Self-tapping screw ($\phi 4 \times 12$)		2
Bind head screw ($\phi 3 \times 6$)		4
Velcro		2

Installation

Changing the transmission frequency

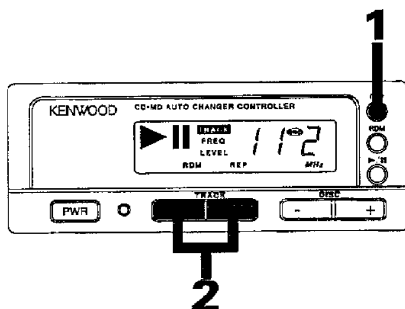

- 1** To set the frequency change mode
Hold down the REP button on the display unit for more than three seconds.
The FREQ indicator will light up and the currently set frequency will be displayed.



NOTE

- The initial value is 88.3MHz.
- If this function is on, the functions other than power on / off, reset, and modulation level / dynamic control, cannot be operated.
- This function is not available when the random play, repeat play, or scan play (KCA-R41FM only) function is on. Before using this function, cancel the other functions. This function cannot be used while loading a disc (while the play indicator is blinking).

- 2** To change the frequency
Press the ◀◀ or ▶▶ button on the display unit.
The transmission frequency will change as follows:

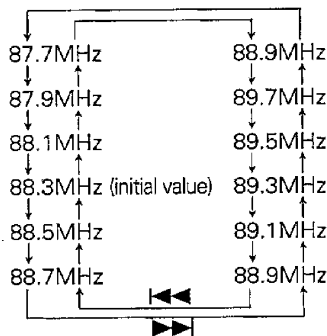

NOTE

Some car radios cannot receive a 87.7 MHz frequency.

To cancel

Hold down the REP button on the display unit for more than three seconds.
The FREQ indicator will go off and the frequency change will take effect.
The frequency change mode is automatically canceled if you do nothing for 15 seconds.

Modulation level / Dynamic control

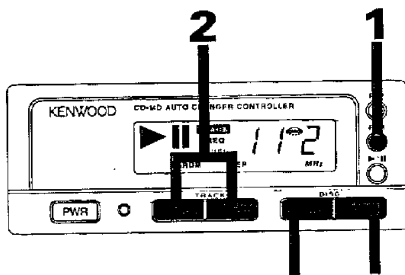

Dynamic control "1" Dynamic control "2"

- 1** To set the control mode
Hold down the RDM button on the display unit for more than three seconds.
The LEVEL indicator will light up and the currently set modulation level will be displayed.

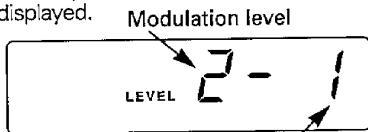

NOTE

Number for prevention of distortion setting

- If this function is on, the functions other than power on / off, reset, and changing the transmission frequency, cannot be operated.
- This function is not available when the random play, repeat play, or scan play (KCA-R41FM only) function is on. Before using this function, cancel the other functions. This function cannot be used while loading a disc (while the play indicator is blinking).

- 2** To change the modulation level
Press the ◀◀ or ▶▶ button on the display unit.
Each time the button is pressed, the modulation level changes in the range from 1 to 4. As the number increases, the modulation level increases. The initial setting is 2.

NOTE

Dynamic control
The unit comes with the prevention of distortion function to reduce sound distortion.
If the sound is distorted severely, press the + button on the display unit and then set the function to "2" (ON).
If the prevention of distortion function is set to "2" (ON), the sound extension is reduced.
The initial setting is "1" (OFF).

CAUTION

If a disc with a high recording level is used, the sound may distort even if the prevention of distortion function is set to "2" (ON). In this case, reduce the modulation level.

To cancel

Hold down the RDM button on the display unit for more than three seconds.
The LEVEL indicator will go off and the modulation level change will take effect.
The control mode is automatically canceled if you do nothing for 15 seconds.

Installation procedure

Installation

1. Remove the ignition key and disconnect the negative (-) terminal of the battery to prevent short circuits.
2. Connect the input and output cables of the units.
3. Connect the ground cable, battery cable, and ignition cable of the wiring harness in the order listed.
4. Connect the wiring harness connectors to the unit.
5. Install the unit in the car.
6. Connect the negative (-) terminal of the battery.
7. Press the Reset button.

⚠ CAUTION

- If the fuse blows, check cables for shorts, then replace the fuse with one of the same rating.
- After installation, check that the brake lamps, wipers, and wipers work properly.
- Some Disc auto-changers require a conversion cord for connection. See the "Safety precautions" for details.
- Use only the supplied screws for installation. Use of any other screws may damage the unit.

Replacing the battery

- Use one lithium battery (CR2025).
- Insert the battery according to the illustration inside the battery case, taking care not to reverse the + and - polarity.
- This battery life is about 6 months, depending on operating conditions. When it expires, replace it.

⚠ WARNING

- Store the lithium battery outside the reach of children. In case a person swallows a lithium battery, immediately call the doctor.

NOTE

- Before using the remote controller for the first time, pull out the film from the battery case.

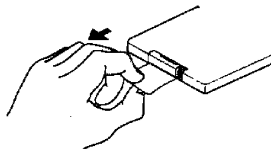

Connections

Installation

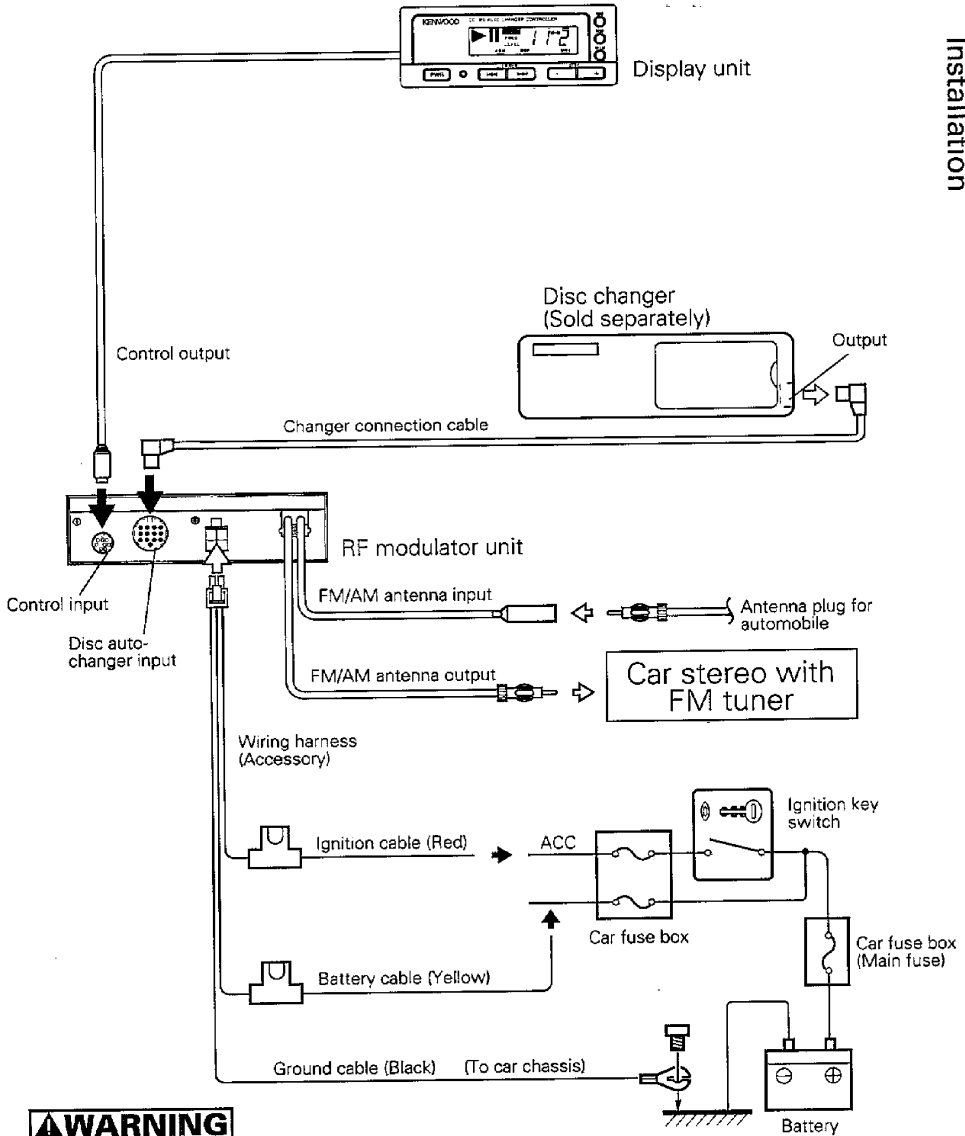

⚠ WARNING

To prevent fire when the ignition cable (Red) or battery cable (Yellow) is short-circuited by coming into contact with the vehicle chassis (ground), only connect the power supply after making the fuse box connections.

Installation

Installation

Installation of Display unit

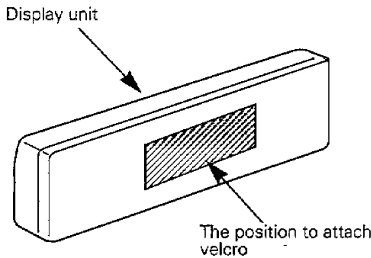

Attach one velcro to the slanted-line of the the display units as shown above, and attach the other velcro to the parts where you wish to attach the display units. Then, put velcros together and install the display units.

CAUTION

- Be sure not to place the unit on such place as where it is exposed to direct sunlight and temperature eventually rises.
It results in the deformation of the case.
- Depending on the installing location, the display unit may not be able to receive the signals from the controller unit. Install them after confirming that the signals can be received.
- Install the unit in such a way that it does not disturb driving.

Installation of RF modulator unit

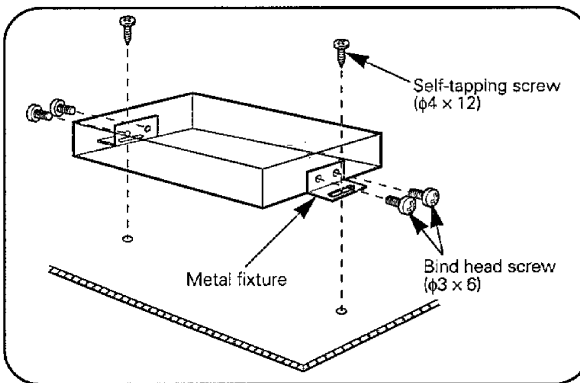

CAUTION

Take sufficient care so that the cables are not caught under the seat. If they are caught, they may break.

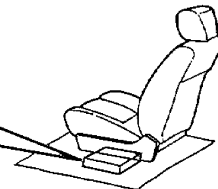

Install the RF modulator unit beneath the front seat using Metal fixture and Bind head screw as shown in the above figure.

Troubleshooting guide

Often, what appears to be a malfunction is due to user error. Before calling for service please consult the following table.

Symptom	Cause	Remedy
The power is not turned on.	The wiring harness fuse blows.	Check cables for shorts, then replace the fuse with one of with the same rating (shown on the case).
No sound or sound is low.	The volume level is minimum.	Raise the volume level.
	The fader or balance is set to one side.	Adjust the fader and balance.
	The input/output cable or wiring harness is connected incorrectly.	Connect the input/output cable or wiring harness correctly. See "Connections" (Page 19).
The unit does not work properly when a button is pressed.	The microcomputer malfunctions.	Press the Reset button of the display unit.
Sound quality is poor. (Sound distortion)	The volume level is too high.	Use the appropriate volume level.
Disc play does not start.	Disc auto-changer input is not connected to the unit.	Connect the Disc auto-changer input to the unit.
	Power button is not turned ON.	Turn the power button ON.
The specified disc is not played; a different disc is played instead.	The specified disc is very dirty.	Check and, if possible, clean the disc. See "Cleaning your discs".
	The disc is loaded upside down.	Eject the disc magazine and insert the disc correctly.
	Two discs are inserted in a slot.	Eject the disc magazine and insert the discs correctly.
	The number of the slot into which the disc is inserted is different from the number of the specified disc.	Eject the disc magazine and check the number of the specified disc.
	The disc is severely damaged.	Use another disc.
Sound skips due to vibration.	Something is touching the Disc auto-changer.	Keep it away from the Disc auto-changer.
	The disc is dirty or damaged.	If sound skips at the same part, the disc is faulty. Check and, if possible, clean the disc. See "Cleaning your discs".
	The unit is mounted at a slant.	Mount the unit so that is level.
	Changer unit is mounted in an unstable place.	Mount the unit in a stable place.
	The angle adjustment switches are set improperly.	Set the angle adjustment switches to the correct positions.
Nothing appears on the display.	The control output of the display unit is not connected properly.	Connect the control output properly.
Sound distortion.	A disc with a high recording level is used.	See Page 17. Change the modulation level / dynamic control setting.

Troubleshooting guide

Symptom	Cause	Remedy
Sound quality is poor.	The recording of the disc is poor.	Try playing another disc. If the sound is good, the fault was with the original disc.
	The disc is dirty or damaged.	Check and, if possible, clean the disc. See "Cleaning your discs".
No sound is heard even though the information concerning the Disc auto-changer is displayed.	Volume is set to minimum level.	Raise the volume level.
	The microcomputer does not function correctly.	Press the Reset button of the display unit.
	The system is not connected properly.	Connect the system properly. See "Connections" (Page 19).
The specified track is not played.	The player is set to RANDOM PLAY.	Turn off RANDOM PLAY.

In some cases, you may see one of the following error messages on your unit's display.

- 01 E:** No disc magazine in changer. Disc magazine is not inserted properly.
⇒ Insert the disc magazine properly.
- 02 E:** No disc in disc magazine.
⇒ Load a disc in the disc magazine.
- 04 E:** Disc is too dirty. The disc is upside down. The disc is damaged.
⇒ Clean the disc and insert it correctly.
- 99 E:** The unit malfunctions due to a defective disc mechanism.
Press the Reset button. If the '99 E' message does not disappear, contact your Kenwood dealer.
- 0d E:** When the temperature exceeds 60°C, a protection circuit will stop all operations. This message will then be displayed.
⇒ Let the place where the changer is located cool down. As soon as it has cooled, the changer starts playing.

Specifications

Specifications subject to change without notice.

Modulating Frequency	87.7, 87.9, 88.1, 88.3, 88.5, 88.7, 88.9, 89.1, 89.3, 89.5, 89.7, 89.9 MHz
----------------------------	--

General

Operating Voltage.....	14.4 V (11 ~ 16 V)
Current consumption.....	0.25 A (When no disc changer is connected)
Operating Temperature.....	-10 ~ 50 °C

Size (W × H × D)	
(Controller) (KCA-R41FM only)	54 × 85 × 5 mm (2-1/8 × 3-3/8 × 3/16 in.)
(Display unit).....	105 × 40 × 18 mm (4-1/8 × 1-9/16 × 11/16 in.)
(RF modulator unit).....	150 × 30 × 120 mm (5-7/8 × 1-3/16 × 4-3/4 in.)

Weight	
(Controller) (KCA-R41FM only)	0.028 kg (0.06 lbs)
(Display unit).....	0.125 kg (0.28 lbs)
(RF modulator unit).....	0.645 kg (1.42 lbs)